

Technical Data Sheet

Product

Model:

AB-2052

Description:

Retrofit-gable style solar powered attic fan constructed from corrosion resistant zincalume alloy steel featuring a 14 inch diameter fan blade, remote mounted 20W solar panel with standard flush mounting brackets, 15 foot UV/weather-resistant power cable, stainless steel hardware throughout, and thermal switch control included.

Revision:

0

Date:

4/1/2017

DCN:

TDS-2052

TOP VIEW

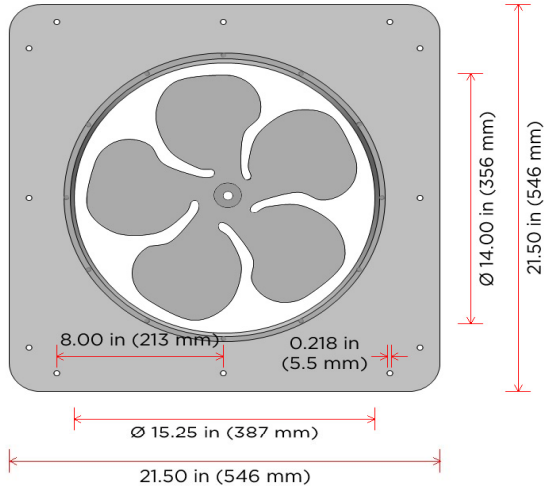

SIDE VIEW

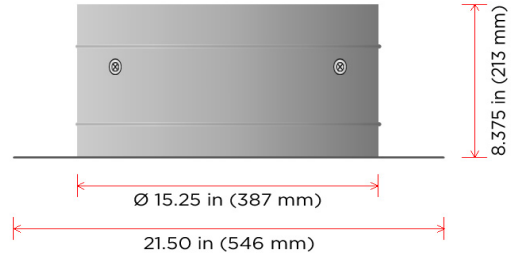

BOTTOM VIEW

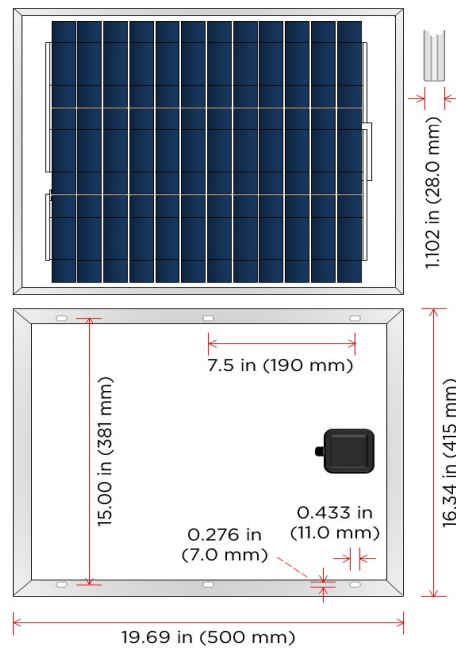
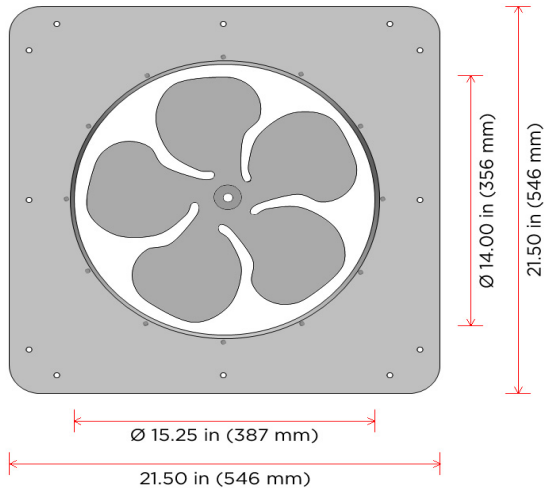

Technical Data Sheet

Materials

Hood & Base:	22 GA (0.027 in; 0.686 mm) Zincalume/Galvalume AZ50 (ASTM A792)
Support Brackets:	N/A
Motor Brackets:	16 GA (0.058 in; 1.473 mm) 304 Stainless Steel (ASTM A666)
Wildlife Screen:	N/A
Hardware & Fasteners:	1/4" 18-8 Stainless Steel
Fan Blade:	16 GA (0.050 in; 1.270 mm) Aluminum AL5052 (ASTM B209); 14 in (356 mm) diameter, 5-wing precision balanced blade
PV Panel:	AL5052 aluminum frame with impact-resistant tempered glass; AL5052 aluminum standard mounting brackets (available with adjustable universal bracket kit)

Finish

Coating Type:	N/A
Coating Thickness:	N/A
Adhesion:	N/A
Exposure Performance:	N/A
Corrosion Resistance:	N/A
Certifications:	N/A
Stock Colors:	N/A
Custom Colors:	N/A

Electrical

Motor:	38V variable speed DC motor with sealed bearings; fully enclosed and designed to be intrinsically safe with overload protection
PV Panel:	High efficiency 20 watt panel; monocrystalline solar cells
Internal Wiring:	16/18 AWG wiring throughout unit
Remote Cable:	18 AWG UV/weather resistant power cable (15 feet); available with 14 AWG extended power cable (40 feet)
Termination:	UV/weather resistant quick disconnect plugs
Fan Control:	Thermal switch included (activates 75°F ± 7°F, deactivates 55°F ± 9°F - UL 873 compliant); Breeze Mate® solar ventilation control system optional

Performance

Max Airflow Rating:	1400 CFM @ 0.0 inH ₂ O under peak sun exposure
Noise Level:	< 1 sones (< 30 dB)
Wind Rating:	N/A
Certifications:	N/A
Warranty:	Residential limited Lifetime Warranty; commercial 25-year limited warranty

Weight Load

Fan Unit:	9 LBS
Remote PV Panel:	5 LBS