

Technical Data Sheet

Product

Model:

AB-3042D

Description:

Curb-mount style solar powered attic fan constructed from corrosion resistant zincalume alloy steel with heavy-duty powder coated finish, featuring a 14 inch diameter fan blade, remote mounted 30W solar panel with standard flush mounting brackets, 15 foot UV/weather-resistant power cable, stainless steel hardware throughout, and thermal switch control included.

Revision:

0

Date:

4/1/2017

DCN:

TDS-3042D

TOP VIEW

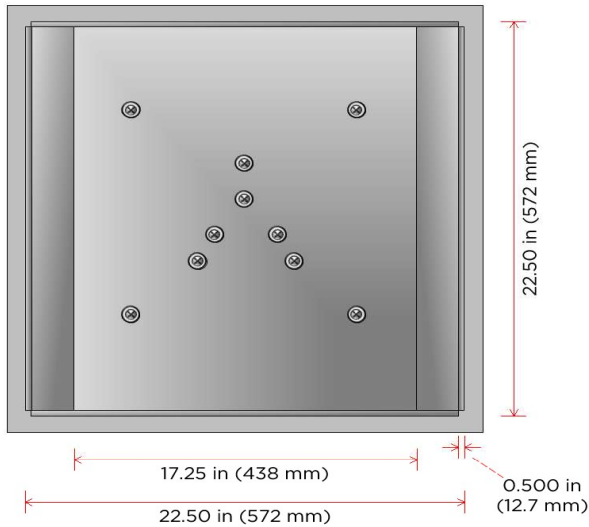

BOTTOM VIEW

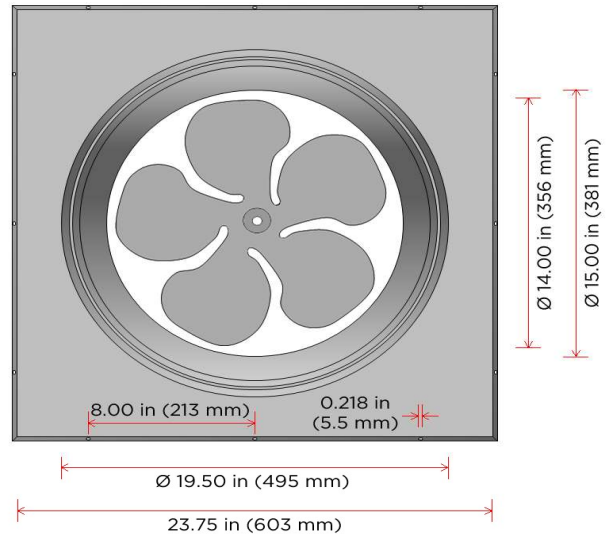

FRONT VIEW

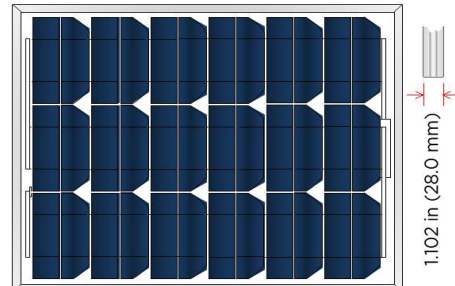
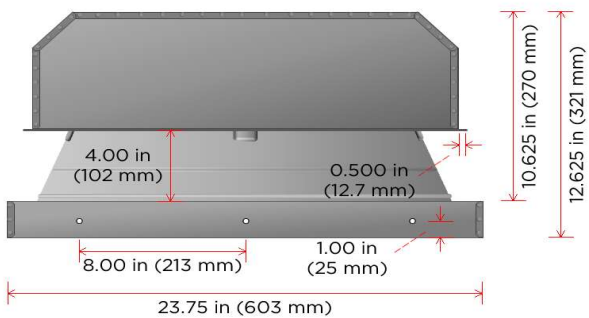

SIDE VIEW

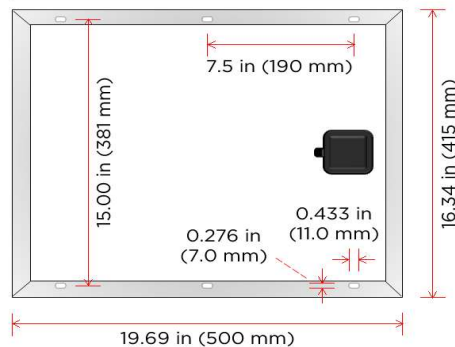
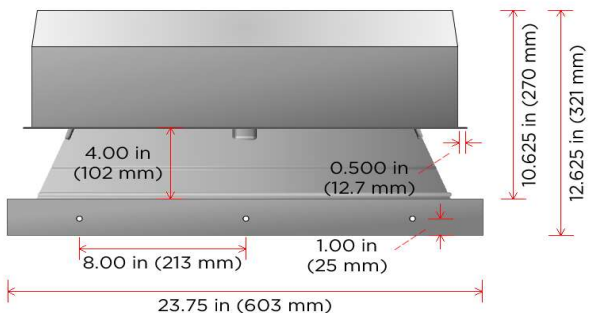

Technical Data Sheet

Materials

Hood & Base:	22 GA (0.027 in; 0.686 mm) Zincalume/Galvalume AZ50 (ASTM A792)
Support Brackets:	16 GA (0.058 in; 1.473 mm) Galvanized Steel G90 (ASTM A653)
Motor Brackets:	12 GA (0.105 in; 2.667 mm) 304 Stainless Steel (ASTM A666)
Wildlife Screen:	23 GA (0.028 in; 0.710 mm) 304 Stainless Steel; 0.25 in x 0.25 in welded wire mesh
Hardware & Fasteners:	1/4" 18-8 Stainless Steel
Fan Blade:	16 GA (0.050 in; 1.270 mm) Aluminum AL5052 (ASTM B209); 14 in (356 mm) diameter, 5-wing precision balanced blade
PV Panel:	AL5052 aluminum frame with impact-resistant tempered glass; AL5052 aluminum standard mounting brackets (available with adjustable universal bracket kit)

Finish

Coating Type:	Powder coated baked-on finish using Tiger/Drylac Series 38 Super Durable TGIC Polyester coating
Coating Thickness:	2.5-3.5 mils average (ISO 2360)
Adhesion:	5B minimum (ASTM D3359 method B)
Exposure Performance:	Passes natural weathering test (ASTM D2244 & ASTM D523; Florida 5 years exposure) with gloss retention >80% and $\leq \Delta E$ 5.0 color change
Corrosion Resistance:	Passes 2,000 hour acid salt spray resistance testing (ASTM G85) with 1/32 in (1 mm) maximum undercutting
Certifications:	AAMA 2604 compliant
Stock Colors:	jet black, bronze brown, weathered gray, polar white, terra cotta, hickory, shakewood
Custom Colors:	brick red, hawaiian blue, anodized silver, classic green, turquoise, sandstone

Electrical

Motor:	38V variable speed DC motor with sealed bearings; fully enclosed and designed to be intrinsically safe with overload protection
PV Panel:	High efficiency 30 watt panel; monocrystalline solar cells
Internal Wiring:	16/18 AWG wiring throughout unit
Remote Cable:	18 AWG UV/weather resistant power cable (15 feet); available with 14 AWG extended power cable (40 feet)
Termination:	UV/weather resistant quick disconnect plugs
Fan Control:	Thermal switch included (activates 75°F \pm 7°F, deactivates 55°F \pm 9°F - UL 873 compliant); Breeze Mate® solar ventilation control system optional

Performance

Max Airflow Rating:	1700 CFM @ 0.0 inH2O under peak sun exposure
Noise Level:	< 1 sones (< 30 dB)
Wind Rating:	+115 PSF/-115 PSF (ASTM E330-02); +170 MPH Wind Speed Equivalence*
* Wind speed equivalence based on 30 foot mean roof height in Exposure B; wind zones 1-3; all roof pitches apply.	
Certifications:	N/A
Warranty:	Residential limited Lifetime Warranty; commercial 25-year limited warranty

Weight Load

Fan Unit:	20 LBS
Remote PV Panel:	5 LBS