

Technical Data Sheet

Product

Model: AB-4022A

Description: Self-flashing style solar powered attic fan constructed from corrosion resistant zincalume alloy steel with heavy-duty powder coated finish, featuring a 14 inch diameter fan blade, unit mounted 40W solar panel with adjustable integrated bracket, stainless steel hardware throughout, thermal switch and fire safety switch included.

Revision: 1

Date: 2/8/2018

DCN: TDS-4022A

TOP VIEW

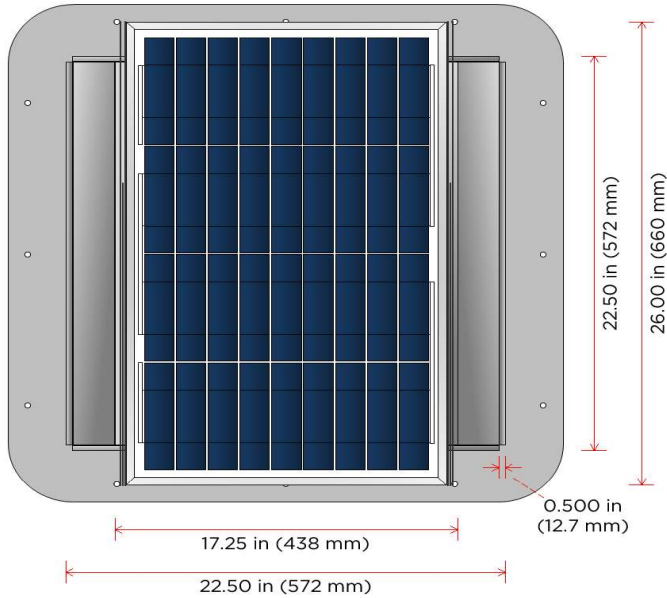

BOTTOM VIEW

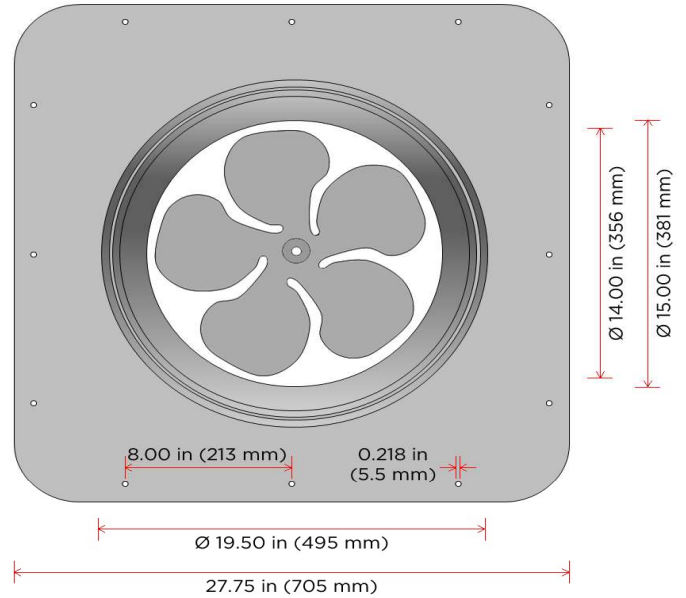

FRONT VIEW

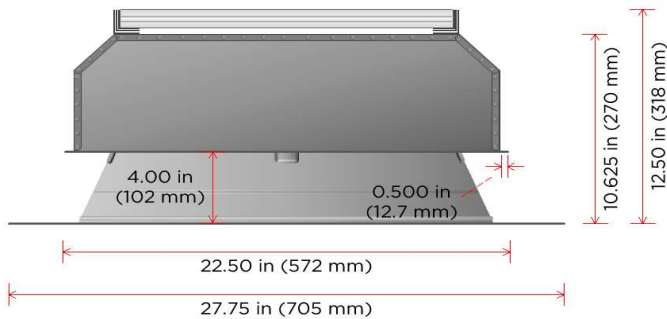

SIDE VIEW

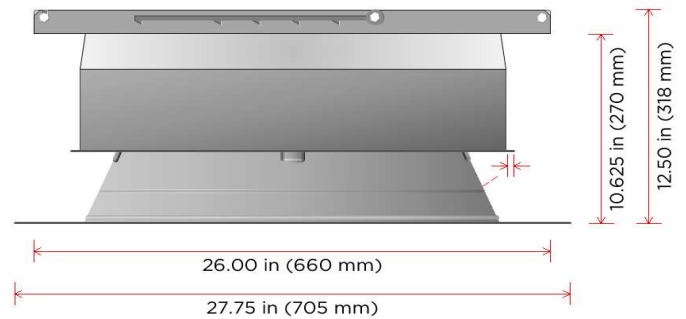

Technical Data Sheet

Materials

Hood & Base:	22 GA (0.027 in; 0.686 mm) Zincalume/Galvalume AZ50 (ASTM A792)
Support Brackets:	16 GA (0.058 in; 1.473 mm) Galvanized Steel G90 (ASTM A653)
Motor Brackets:	12 GA (0.105 in; 2.667 mm) 304 Stainless Steel (ASTM A666)
Wildlife Screen:	23 GA (0.028 in; 0.710 mm) 304 Stainless Steel; 0.25 in x 0.25 in welded wire mesh
Hardware & Fasteners:	1/4" 18-8 Stainless Steel
Fan Blade:	16 GA (0.050 in; 1.270 mm) Aluminum AL5052 (ASTM B209); 14 in (356 mm) diameter, 5-wing precision balanced blade
PV Panel:	AL5052 aluminum frame; impact-resistant tempered glass

Finish

Coating Type:	Powder coated baked-on finish using Tiger/Drylac Series 38 Super Durable TGIC Polyester coating
Coating Thickness:	2.5-3.5 mils average (ISO 2360)
Adhesion:	5B minimum (ASTM D3359 method B)
Exposure Performance:	Passes natural weathering test (ASTM D2244 & ASTM D523; Florida 5 years exposure) with gloss retention >80% and $\Delta E \leq 5.0$ color change
Corrosion Resistance:	Passes 2,000 hour acid salt spray resistance testing (ASTM G85) with 1/32 in (1 mm) maximum undercutting
Certifications:	AAMA 2604 compliant
Stock Colors:	jet black, bronze brown, weathered gray, polar white, terra cotta, hickory, shakewood
Custom Colors:	brick red, hawaiian blue, anodized silver, classic green, turquoise, sandstone

Electrical

Motor:	38V variable speed DC motor with sealed bearings; fully enclosed and designed to be intrinsically safe with overload protection
PV Panel:	High efficiency 40 watt panel; monocrystalline solar cells
Internal Wiring:	16/18 AWG wiring throughout unit
Remote Cable:	N/A
Termination:	UV/weather resistant quick disconnect plugs
Fan Control:	Includes thermal switch (activates 75°F \pm 7°F, deactivates 55°F \pm 9°F - UL 873 compliant) and fire safety switch (deactivates at 228°F +0°F/-9°F - UL 60691 compliant); Breeze Mate® solar ventilation control system optional

Performance

Max Airflow Rating:	1875 CFM @ 0.0 inH ₂ O active under peak sun exposure; 1.31 sqft NFA passive
Noise Level:	< 1 sones (< 30 dB)
Wind Rating:	+115 PSF/-115 PSF (ASTM E330-02); +170 MPH Wind Speed Equivalence*

* Wind speed equivalence based on 30 foot mean roof height in Exposure B; wind zones 1-3; all roof pitches apply.

Certifications:	Florida Product Approval (FL13339.1 R6); Texas Department of Insurance windstorm approval (RV-59)
Warranty:	Residential limited Lifetime Warranty; commercial 25-year limited warranty

Weight Load

Fan Unit:	33 LBS
Remote PV Panel:	N/A